

➤ Instructions

Thule Vector

613200, 613201, 613500, 613501, 613700, 613701

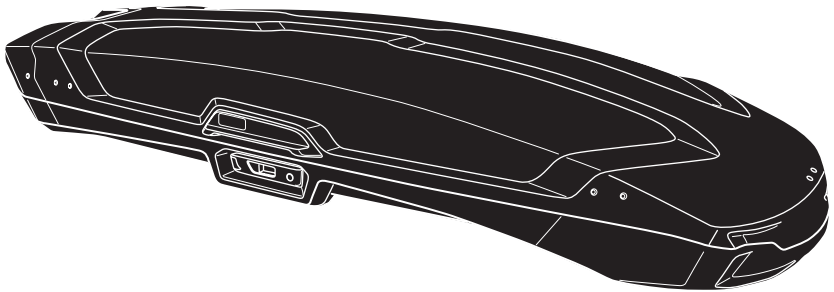

- EN** Roof box for roof-mounted racks
DE Dachbox für Dachträger
FR Coffre pour barres de toit
NL Dakkoffer
IT Box da tetto per portapacchi da installare sul tetto
ES Cofre portaequipajes para barras de techo
PT Caixa bagageira para barras de tejadilho
SV Takbox för takmonterade räckor
DK Tagboks til tagbjælter
NO Takboks til takmonterte stativer
FI Katolle asennettaviin telineisiin sopiva kuljetuslaatikko
ET Katusele paigaldatav katuseboks
LV Jumta kaste uz jumta uzstādāmiem bagāžniekiem
LT Ant stogo tvirtinamų skersinių bagažinės
PL Box dachowy na bagażnik montowany na dachu
RU Грузовой бокс на крышу автомобиля
UK Вантажний бокс для багажників для даху
BG Кутия за багаж за релси, монтирани върху покрива
CS Střešní box pro montáž na střeche
SK Strešný box na strešné nosiče

- SL** Strešni kovček za strešne prtljažnike
HR/BIH Krovna kutija za krovne nosače
RO Portbagaj de acoperiș pentru cadru de bare montate pe acoperiș
HU Tetőre szerelhető tetőbox
EL Μπαγκάζιέρα οροφής για μπάρες οροφής
TR Araç üstüne bağlanan raflar için tavan kutusu
HE תא חפצים ללגג הרכב
AR صندوق سقف للحوامل المثبتة على السقف
ZH 用于车顶架的车顶箱
JA ルーフマウント型ラック用ルーフボックス
KO 루프 장착 랙 루프 박스
TH กล่องบนหลังคาสำหรับแร็คหลังคา

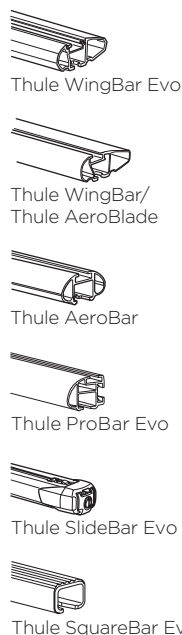
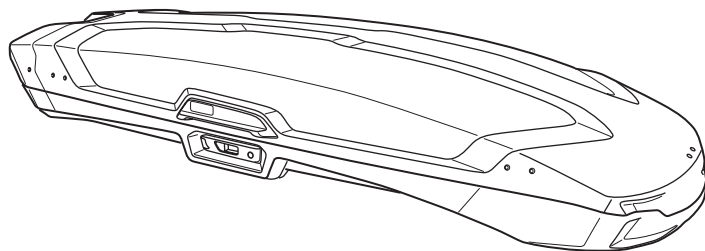
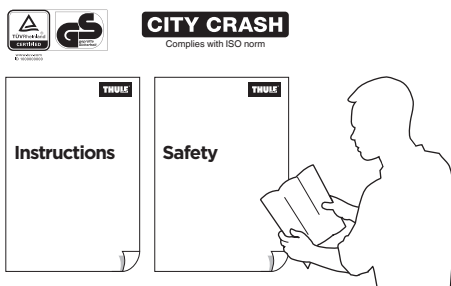

x1



x3



x2

i

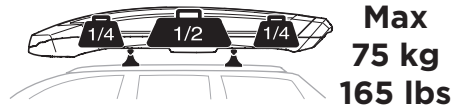

	Weight		Volume
Medium	29 kg	65 lbs	360 litre
Alpine	30 kg	66 lbs	380 litre
Large	30 kg	66 lbs	430 litre

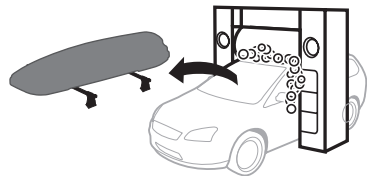
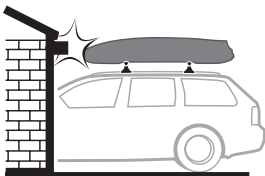
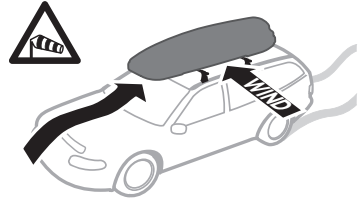
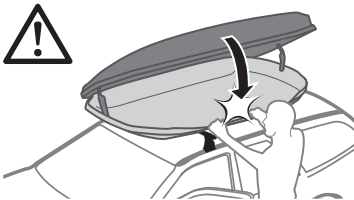
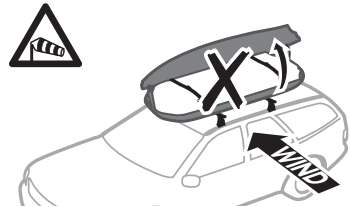
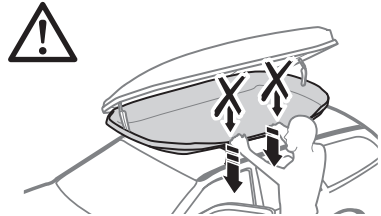
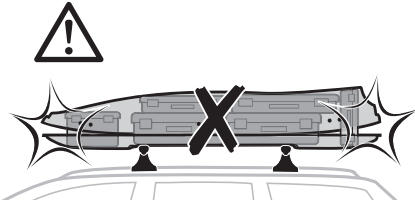
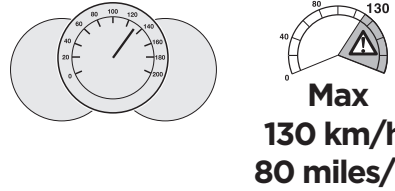

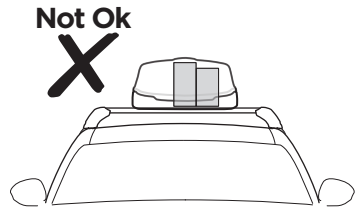
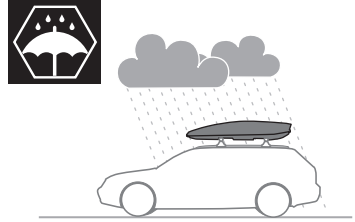
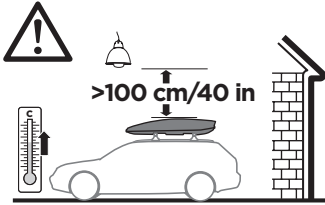
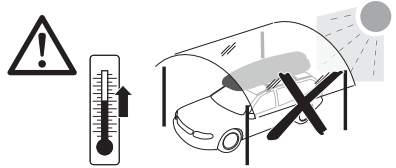
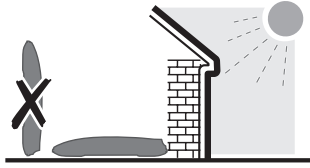

i

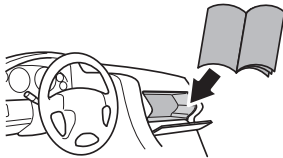

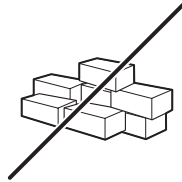
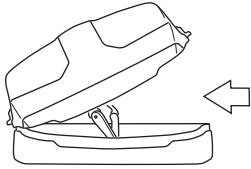

i

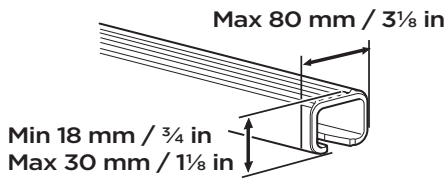

Thule T-track Adapter

696600
697600

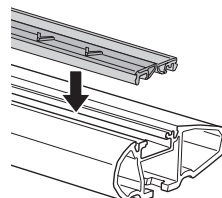
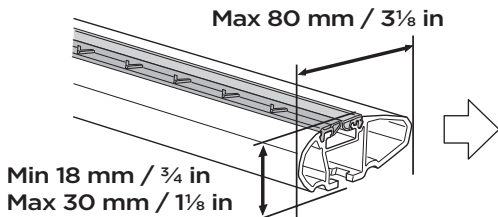

i

		D Min	D Max	W in	W out	H	L	R Min
Medium	mm	557	932	780	880	297	2120	1310
	in	21 ⁷ / ₈	36 ³ / ₄	30 ³ / ₄	34 ⁵ / ₈	11 ³ / ₄	83 ¹ / ₂	51 ¹ / ₂
Alpine	mm	557	932	780	884	284	2280	1370
	in	21 ⁷ / ₈	36 ³ / ₄	30 ³ / ₄	34 ³ / ₄	11 ¹ / ₈	89 ³ / ₄	53 ⁷ / ₈
Large	mm	557	932	780	884	329	2315	1410
	in	21 ⁷ / ₈	36 ³ / ₄	30 ³ / ₄	34 ³ / ₄	13	91 ¹ / ₈	55 ³ / ₈

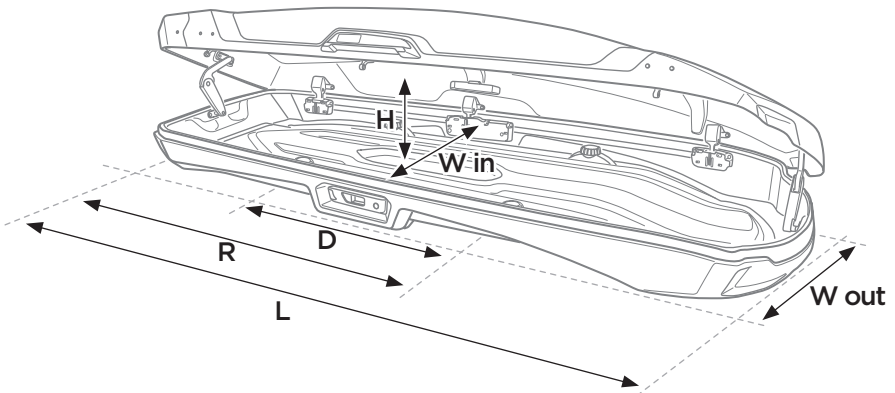
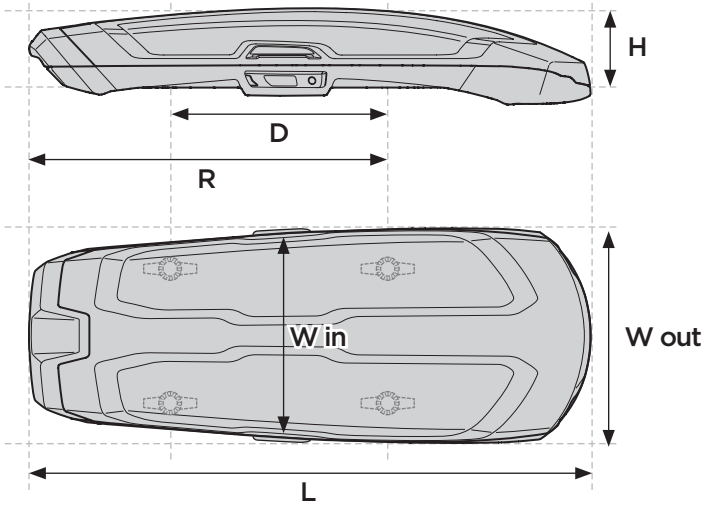

1

i

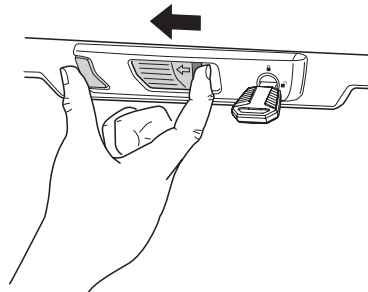
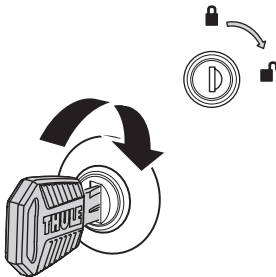
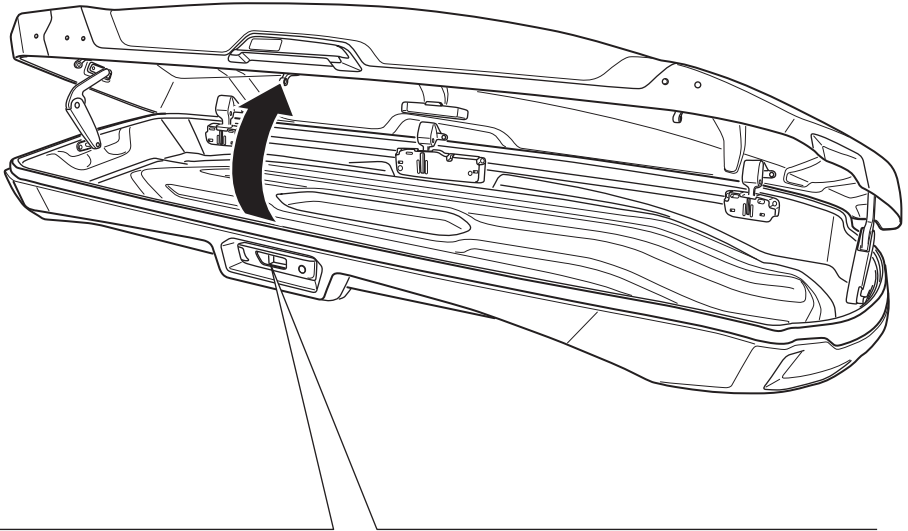
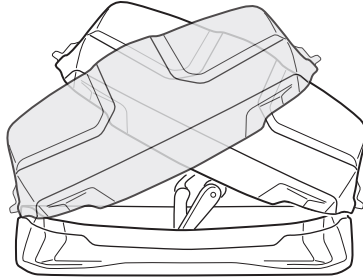

2

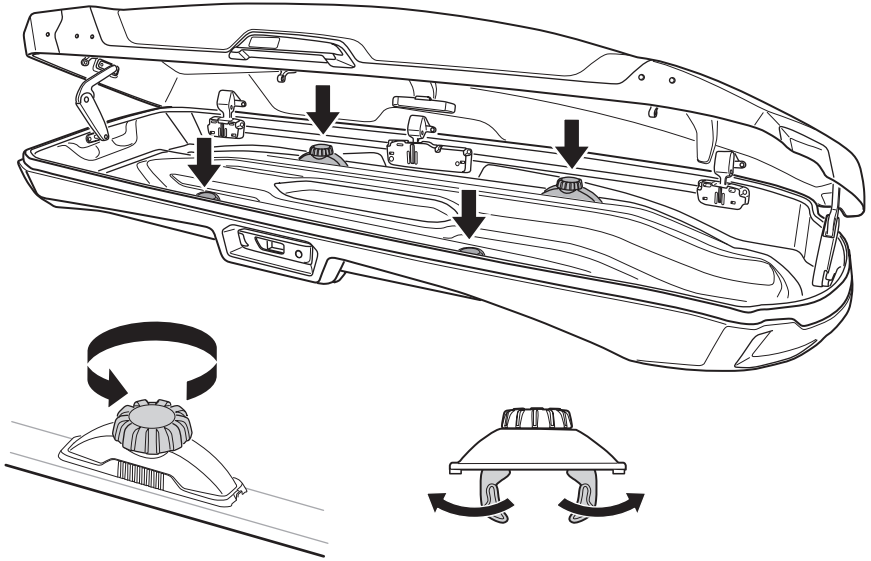

i



x 2

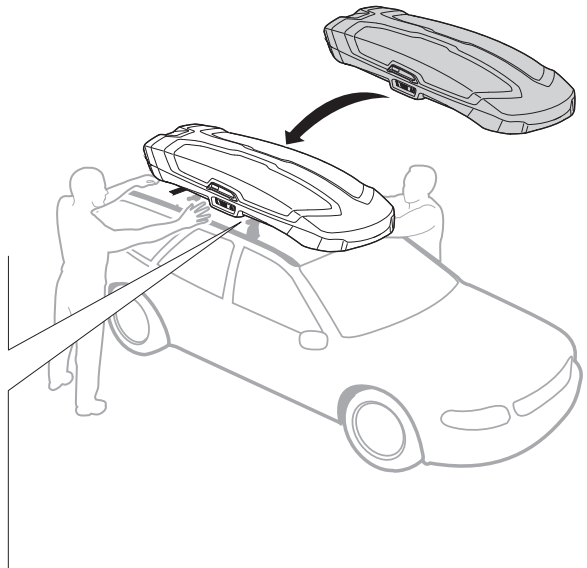
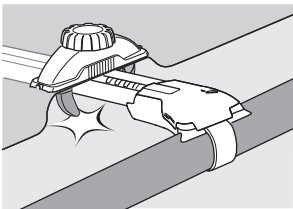

3

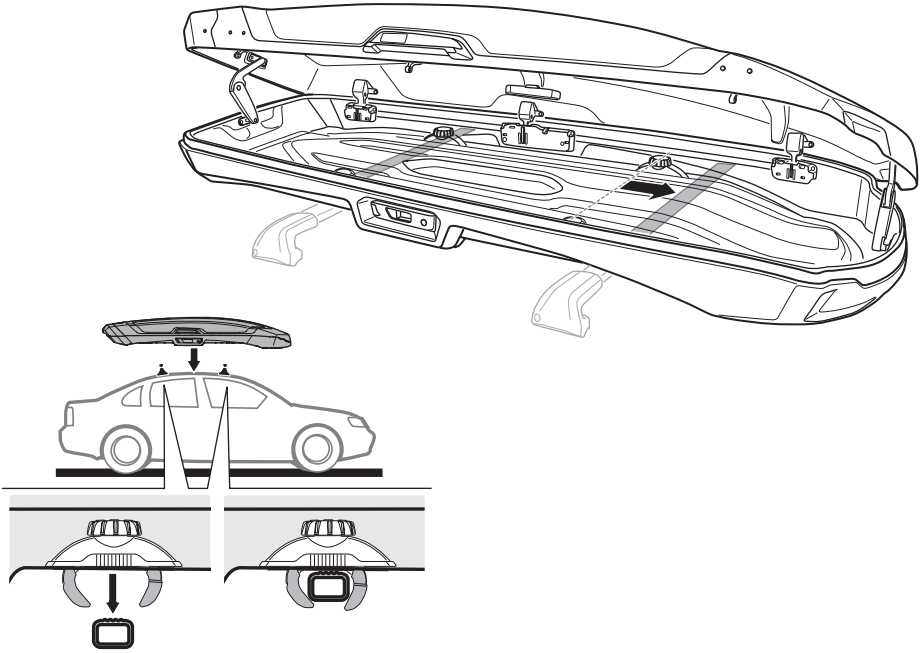

4

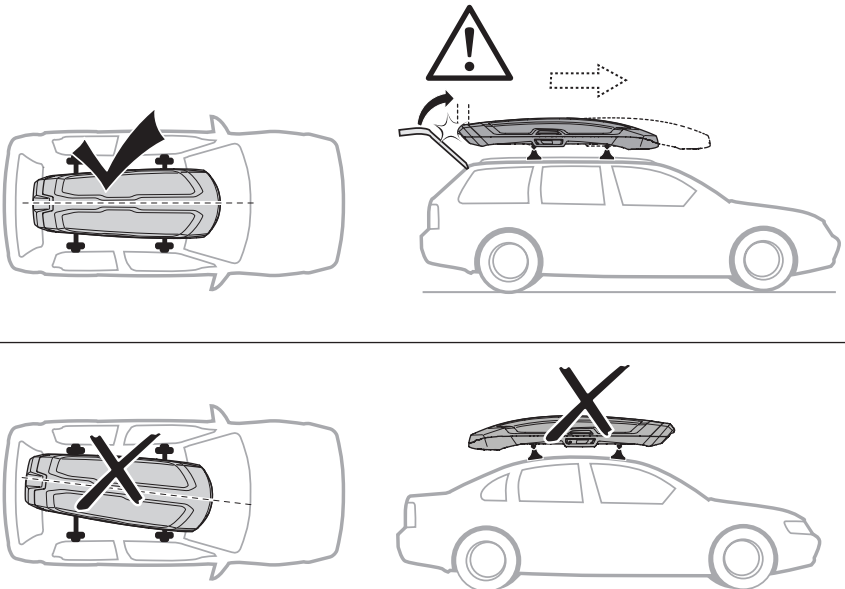

5

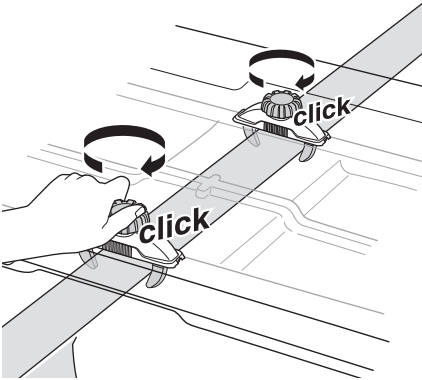
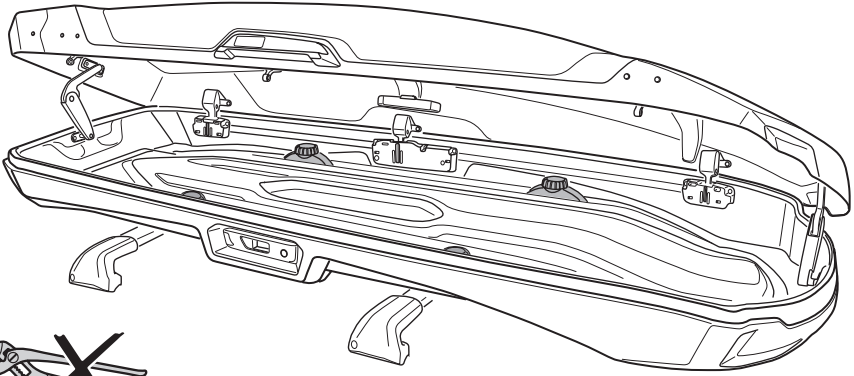

i

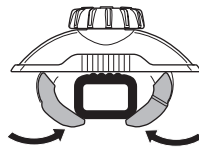
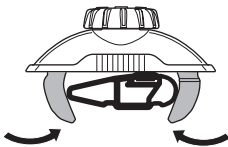
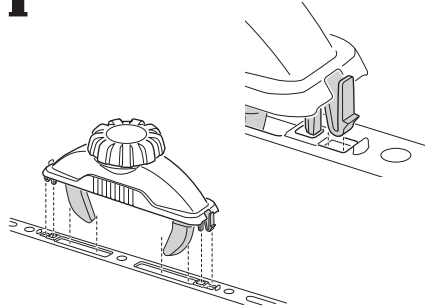

Ok
✓

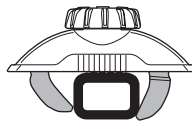
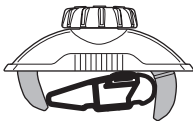

Not Ok
✗

i

CE

LED



IP43

-30°C
+60°C

50000x

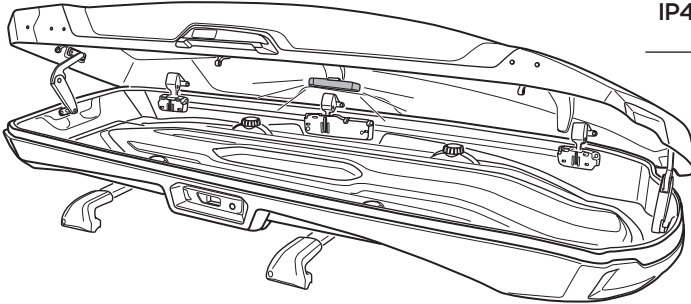

6

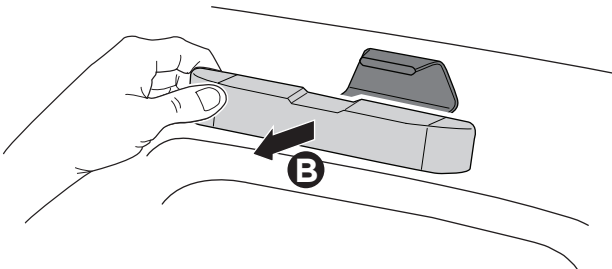
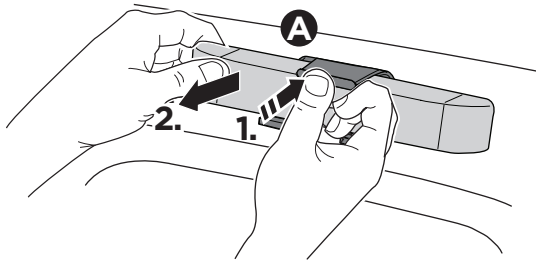
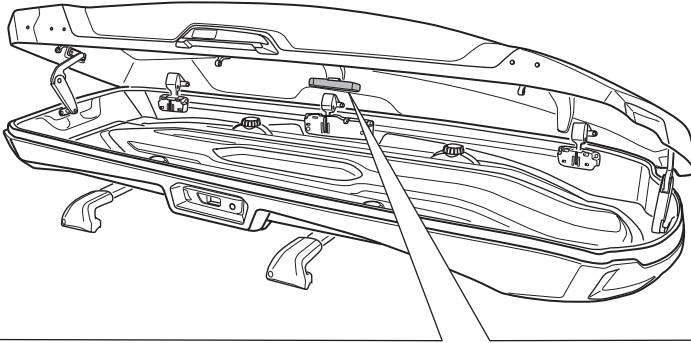

7

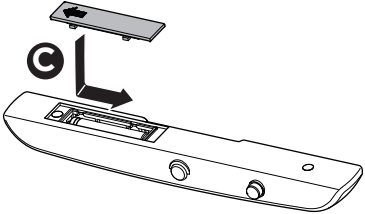
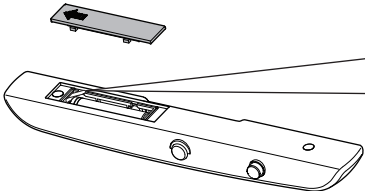
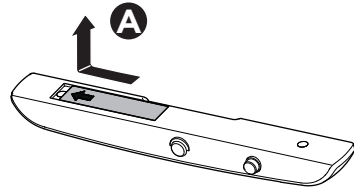

3 x Energizer L92
(1.5 VDC)

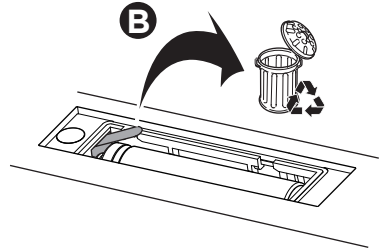

8

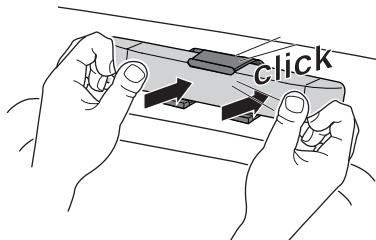
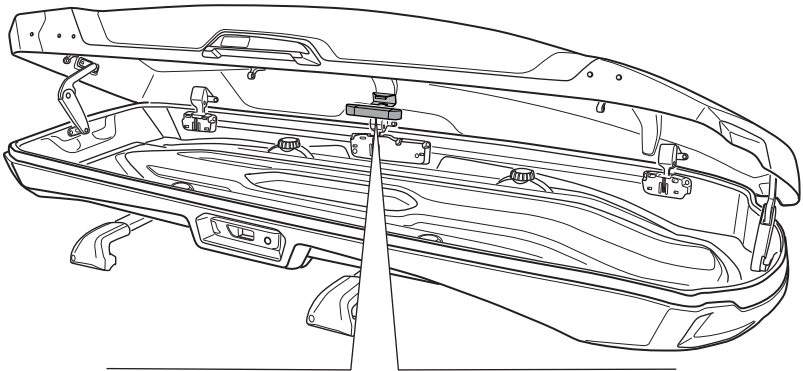

9

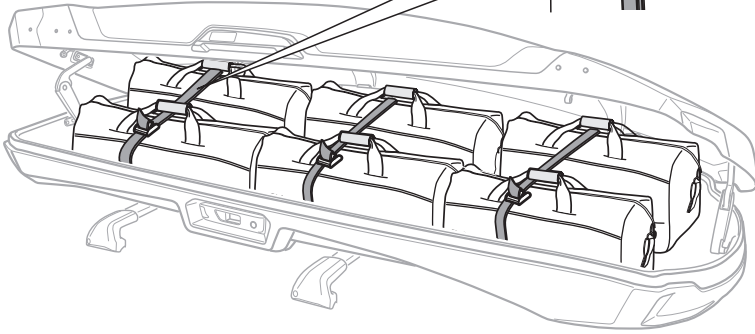
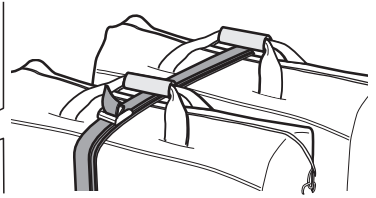
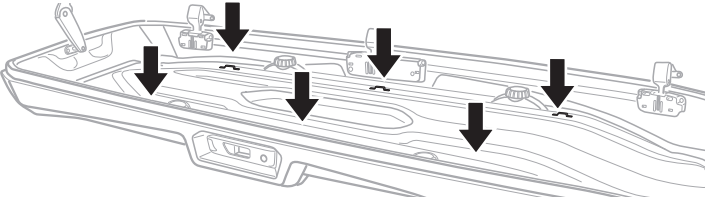
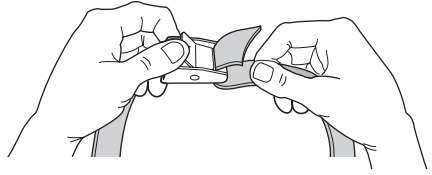

Not Ok

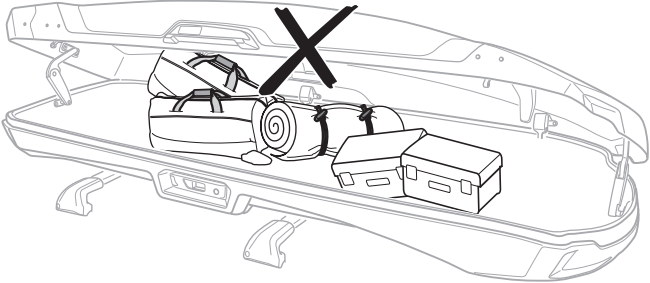

10

A

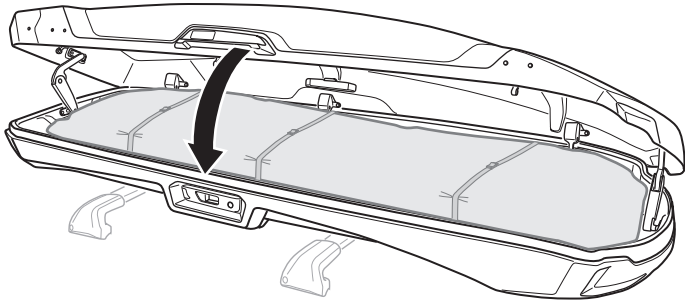

B

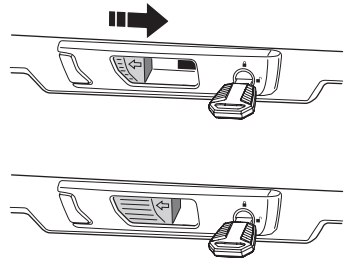
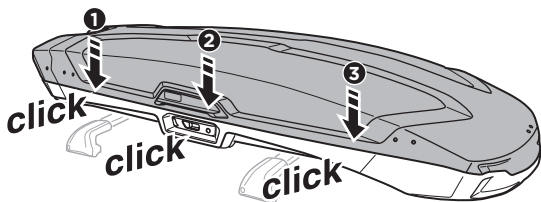

C



Not ok
X

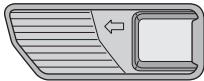

ok
✓ →

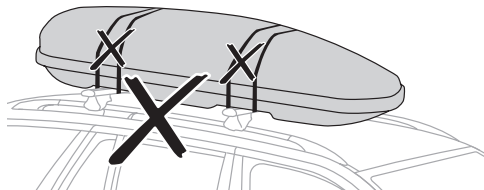
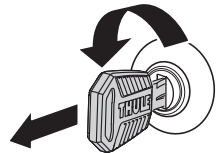
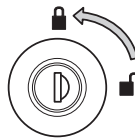

11

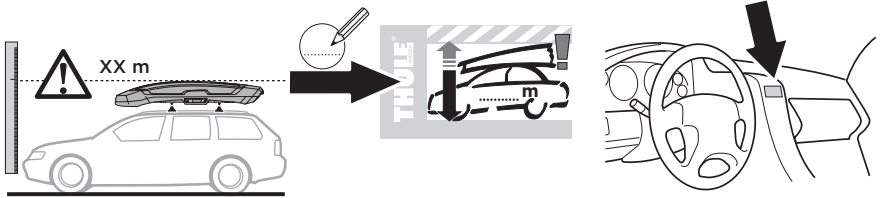

i

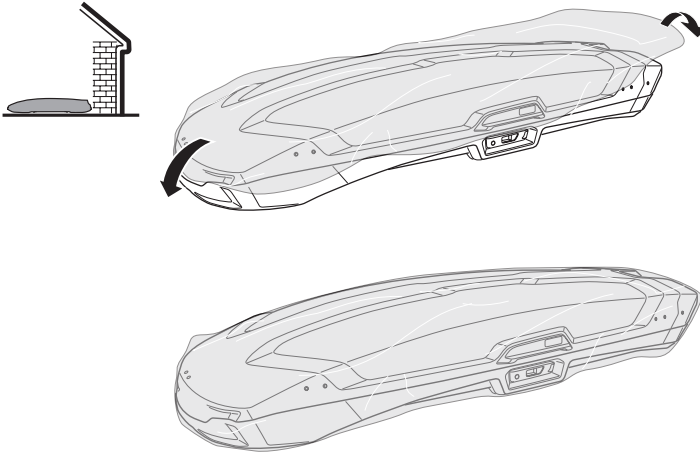

i

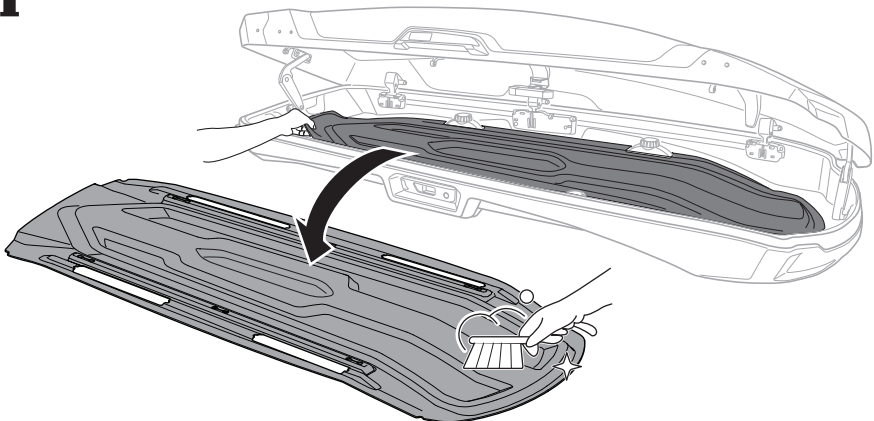

EN Accessories	DK Tilbehør	UK Аксессуары	EL Εξαρτήματα
DE Zubehör	NE Tilbehør	BG Принадлежности	TR Aksesuarlar
FR Accessoires	FI Lisävarusteet	CS Doplňky	AR الملحقات
NL Accessoires	ET Lisavarustus	SK Príslušenstvo	HE מוצרי
IT Accessori	LV Piederumi	SL Dodatki	ZH 附件
ES Accesorios	LT Priedai	HR/BIH Dodaci	JA アクセサリー
PT Acessórios	PL Akcesoria	RO Accesorii	KO 액세서리
SV Tillbehör	RU Аксессуары	HU Tartozékok	TH อุปกรณ์เสริม

Thule One-Key System

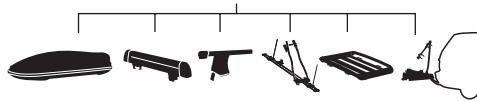

450400 (x4)

450600 (x6)

450800 (x8)

451200 (x12)

451600 (x16)

Thule T-track Adapter

696600

24x30 mm

697600

20x27 mm

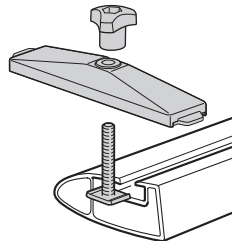

20/24

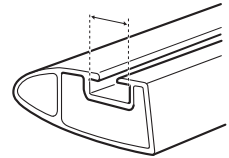

Thule MultiLift

572004

